

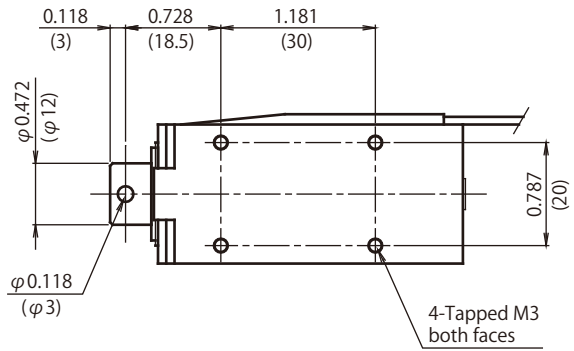

DIMENSIONS ARE  $\frac{\text{INCHES}}{\text{MILLIMETERS}}$

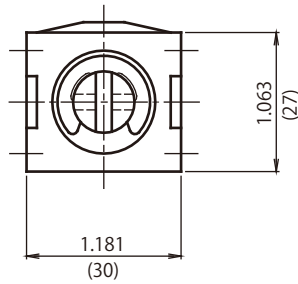
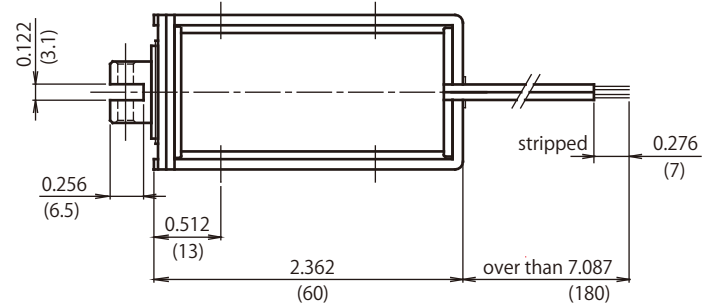

Adsorbed position

### Duty Cycle

Insulation Class A 105°C(221°F)

Part Number	Coil	Rated	Rated	Rated
	Resistance	DC6V	DC12V	DC24V
CA12600060	6 Ohms	100%	25%	6%
CA12600100	10 Ohms	-	40%	10%
CA12600260	26 Ohms	-	100%	25%
CA12600510	51 Ohms	-	-	50%
CA12601030	103 Ohms	-	-	100%

### Graph Force - Stroke

DC24V 20°C(68°F)

