

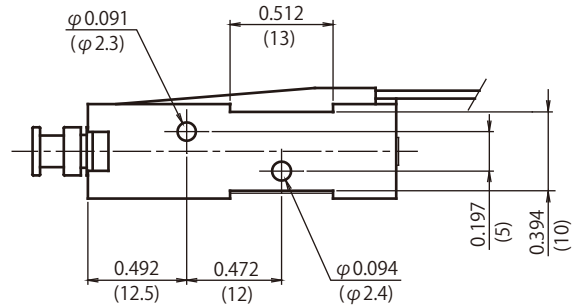

DIMENSIONS ARE $\frac{\text{INCHES}}{\text{MILLIMETERS}}$

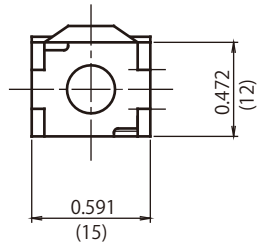
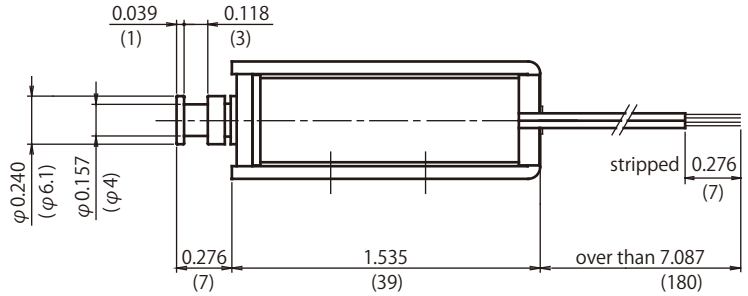

Adsorbed position

Duty Cycle

Insulation Class A 105°C(221°F)

Part Number	Coil	Rated	Rated	Rated
	Resistance	DC6V	DC12V	DC24V
CA06390150	15 Ohms	100%	25%	6%
CA06390240	24 Ohms	-	40%	10%
CA06390600	60 Ohms	-	100%	25%
CA06391200	120 Ohms	-	-	50%
CA06392400	240 Ohms	-	-	100%

Graph Force - Stroke

DC24V 20°C(68°F)

